

Rohde & Schwarz Products: FSP, FSQ, FSU, FS-K73, FS-K74, SMU200A, SMU-K43, WiniQSIM, CMU200, CMU300, CMU-K64, CMU-K79, CRTU-M, CRTU-W, CRTU-WA01, CRTU-WA02, CRTU-WT02

High Speed Downlink Packet Access (HSDPA)

Test and Measurement Requirements

Application Note 1MA82

This Application Note introduces HSDPA technology and test and measurement requirements according to 3GPP release 5 specifications. Important HSDPA measurements and example applications are illustrated by means of Rohde & Schwarz products.



Contents

1	Overview	3
2	HSDPA Technology	4
3	Node B Test and Measurement Requirements for HSDPA	10
	Relevant 3GPP Specifications	10
	Rohde & Schwarz Test Equipment and Software	11
	Example Applications	11
4	UE Test and Measurement Requirements for HSDPA.....	14
	Relevant 3GPP Specifications	14
	Rohde & Schwarz Test Equipment and Software	16
	Example Applications	17
5	Abbreviations.....	25
6	Additional Information.....	26
7	References	27
8	Ordering information	27

The following abbreviations are used in this application note for R&S test equipment:

- The Vector Signal Generator R&S® SMU200A is referred to as the SMU200A.
- The Spectrum Analyzer R&S® FSP and FSU are referred to as FSP and FSU.
- The Signal Analyzer R&S® FSQ and FSIQ are referred to as FSQ and FSIQ.
- FSP, FSU and FSQ in general is referred to as the FSx.
- The Protocol Tester R&S® CRTU-W is referred to as CRTU-W.
- The Universal Radio Communication Tester R&S® CMU200 is referred to as CMU200.
- The Universal Radio Communication Tester R&S® CMU300 is referred to as CMU300.

1 Overview

Following in the footsteps of GSM, GPRS, and UMTS, now HSDPA (High Speed Downlink Packet Access) has stepped forward as the latest development in mobile radio technology. The objective of HSDPA is optimization of the UMTS system with respect to data services support. UMTS already offers fast data services, such as high-quality video transmission at 384 kbit/s. Building on that, HSDPA uses new technologies to enable data rates of theoretically up to 14 Mbit/s, as well as to increase the capacity of the mobile radio network. As a result, mobile radio operators can offer their customers even more sophisticated multimedia services. HSDPA is particularly suited to extremely asymmetrical data services, which require significantly higher data rates for the transmission from the network to the UE (downlink) than they do for the transmission from the UE to the network (uplink). In addition to providing the desired data rates and maximizing data throughput, HSDPA is intended to increase the robustness of these data services, which typically exhibit only a low tolerance for errors.

HSDPA requires dedicated test and measurement solutions. Besides measuring physical values, the new HSDPA specific layer 1 processes and protocol mechanisms must be verified in detail. This application note outlines requirements for HSDPA Node B and UE test according to 3GPP release 5 specifications. Important HSDPA measurements and example applications are illustrated by means of Rohde & Schwarz products.

Chapter 2 gives an HSDPA technology overview.

Chapter 3 provides an overview of Node B specific test and measurement requirements related to HSDPA as specified in 3GPP release 5. Rohde & Schwarz instruments for Node B test are introduced, and example application areas are illustrated.

Chapter 4 outlines UE specific test and measurement requirements related to HSDPA, covering RF, layer 1 and protocol issues. Rohde & Schwarz instruments for UE tests are introduced, and example application areas are highlighted.

Chapters 5 to 8 provide additional information including literature references.

2 HSDPA Technology

Principle

HSDPA is based on a combination of technologies. Significant is the introduction of a new transmission channel for the user data, the High Speed (Physical) Downlink Shared Channel, **HS-(P)DSCH**. Multiple users share the air interface resources available on this channel. An intelligent algorithm in the Node B decides which subscriber will receive a data packet at which time. This decision is reported to the subscribers via a parallel signalling channel, the High Speed Shared Control Channel, **HS-SCCH**. In contrast to UMTS, where a new data packet can be transmitted at least every 10 ms, with HSDPA data packet transmission can occur every 2 ms.

Another important innovation is the use of an **adaptive modulation and coding** procedure. Every subscriber regularly sends messages regarding the channel quality to the Node B. Depending on the quality of the mobile radio channel, the Node B selects a suitable modulation and coding for the data packet that offers satisfactory protection against transmission errors, and that optimizes the use of resources on the air interface. The Node B can select from the modulation methods QPSK (quadrature phase shift keying) and 16QAM (quadrature amplitude modulation). While QPSK is already being used in UMTS release 99, 16QAM provides high data rates specifically for HSDPA.

In order to achieve robust data transmission, HSDPA uses a **HARQ** (Hybrid Automatic Repeat Request) protocol. If a UE receives a data packet with errors, it requests the data packet again. When repeating the packet transmission, the Node B can select a different coding version that provides the subscriber with better reception of the packet (incremental redundancy). This coding version is often referred to as “redundancy and constellation version” or in short “redundancy version” (RV version). When a packet has been transmitted to the UE, the Node B has to wait until an acknowledgement (ACK) or negative acknowledgement (NACK) is received for this particular packet (so-called stop-and-wait transmission mechanism). In the meanwhile, the Node B can transmit other data packets to this UE on other HARQ processes. One UE has to support up to 8 parallel HARQ processes which are equivalent to up to 8 independent HARQ stop-and-wait transmission mechanisms.

HSDPA Test and Measurement Requirements

User feedback about channel quality as well as packet acknowledgements or negative acknowledgements are provided in the uplink on the High Speed Dedicated Physical Control Channel, **HS-DPCCH**.

The overall HSDPA scheme and the new channels are illustrated in the following figure:

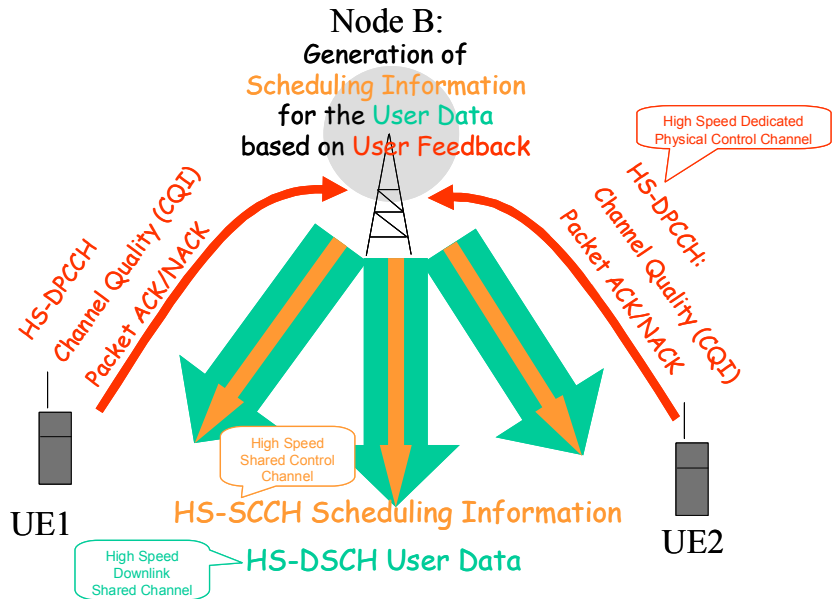

Figure 1 – HSDPA Principle

After this overall view on the the HSDPA principle, the new physical and transport channels are explained in more detail in the following:

HS-(P)DSCH Structure

The transport channel HS-DSCH is mapped on one or more physical channels of type HS-PDSCH. The HS-PDSCH is always spread with spreading factor 16. One HS-DSCH transport block is transmitted in a transmission time interval (TTI) of 2 ms (corresponding to 3 timeslots). If UE category (indicating the UE capabilities as specified in 3GPP TS 25.306 [1]) allows, HS-DSCH transport blocks can be scheduled to the UE continuously, i.e. in every TTI. Less complex UEs corresponding to a lower UE category can only process data received in every second or even every third TTI. This is described by the so-called **inter TTI distance** parameter. An inter TTI distance of 1 equals continuous HS-PDSCH transmission (in case data is available for transmission).

QPSK or 16QAM are available as modulation scheme on the HS-PDSCH. Figure 2 outlines the structure of the HS-(P)DSCH.

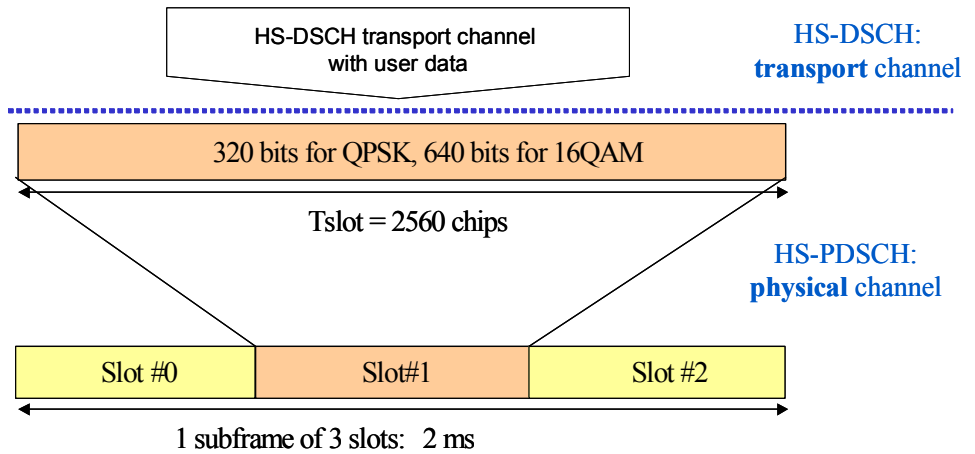

Figure 2 - Structure of HS-(P)DSCH

HS-SCCH Structure

The HS-SCCH is a fixed rate downlink physical channel, spread with spreading factor 128. One UE has to monitor up to 4 HS-SCCH channels. The UE is informed by higher layers at call setup which HS-SCCH channels to monitor. The HS-SCCH contains scheduling and control information (UE identification, HS-PDSCH channelization codes, HS-PDSCH modulation scheme information, transport block size information, HARQ process information, redundancy and constellation version, new data indicator). Figure 3 outlines the HS-SCCH structure:

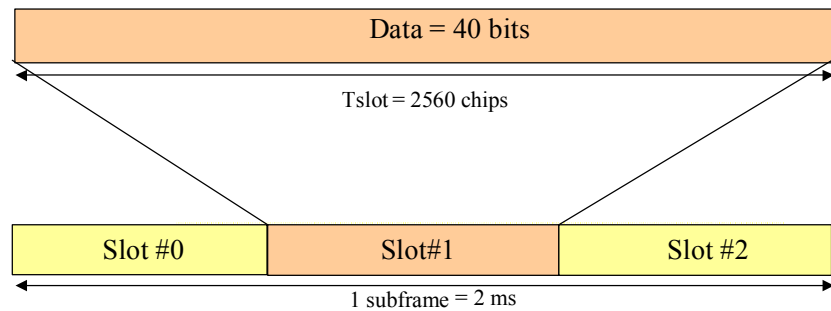

Figure 3 –Structure of HS-SCCH

The HS-PDSCH starts 2 timeslots after the start of the corresponding HS-SCCH.

HS-DPCCH Structure

The HS-DPCCH is an uplink physical channel used to carry control information: HARQ ACK/NACK and Channel Quality Information. Figure 4 outlines the structure of the HS-DPCCH.

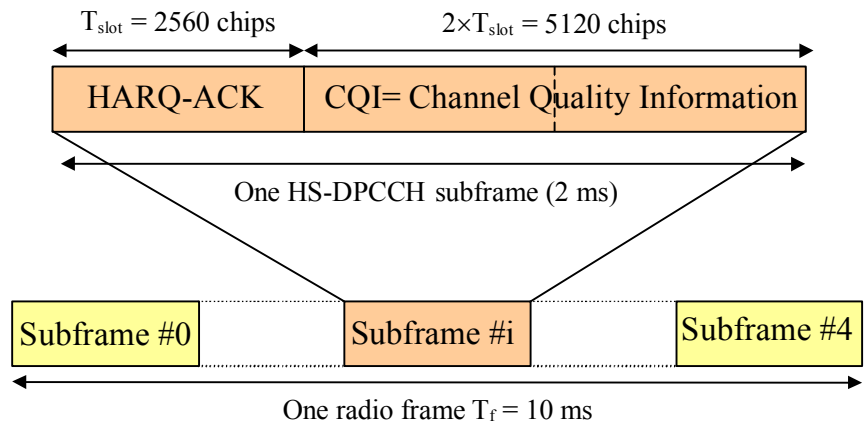

Figure 4 – Structure of HS-DPCCH

The Channel Quality Information consists of a CQI value that is referring to CQI tables as specified in 3GPP TS 25.214 [2]. There are different tables specified for different UE categories [1], reflecting the level of UE implementation complexity. For example, table 1 shows the CQI table for UE categories 1-6. The CQI values regularly reported by the UE are interpreted by the Node B as proposal how to format the HS-(P)DSCH. With this format, the resulting block error rate of the HS-DSCH is predicted by the UE to be below 0.1. The higher the CQI value, the more demanding the HS-DSCH transmission format, i.e. the better the radio link quality has to be.

Example: if the UE reports a value of 14 according to table 1 (corresponding row is highlighted), it proposes a HS-(P)DSCH format of transport block size 2583 bits, 4 channelization codes, and QPSK modulation. With an HS-(P)DSCH formatted like this, the UE estimates the transport block error rate of HS-DSCH to be below 0.1. If the Node B ignored the recommendation of the UE and selected a more demanding transmission format according to a higher CQI value, then a higher transport block error rate would very likely occur on HS-DSCH. Thus, the Node B should ideally select a transport format according to UE recommendations.

HSDPA Test and Measurement Requirements

Table 1 - CQI mapping table for UE categories 1 to 6

CQI value	Transport Block Size	Number of HS-PDSCH	Modulation	Reference power adjustment Δ	N _{IR}	X _{RV}
0	N/A	Out of range				
1	137	1	QPSK	0	9600	0
2	173	1	QPSK	0		
3	233	1	QPSK	0		
4	317	1	QPSK	0		
5	377	1	QPSK	0		
6	461	1	QPSK	0		
7	650	2	QPSK	0		
8	792	2	QPSK	0		
9	931	2	QPSK	0		
10	1262	3	QPSK	0		
11	1483	3	QPSK	0		
12	1742	3	QPSK	0		
13	2279	4	QPSK	0		
14	2583	4	QPSK	0		
15	3319	5	QPSK	0		
16	3565	5	16-QAM	0		
17	4189	5	16-QAM	0		
18	4664	5	16-QAM	0		
19	5287	5	16-QAM	0		
20	5887	5	16-QAM	0		
21	6554	5	16-QAM	0		
22	7168	5	16-QAM	0		
23	7168	5	16-QAM	-1		
24	7168	5	16-QAM	-2		
25	7168	5	16-QAM	-3		
26	7168	5	16-QAM	-4		
27	7168	5	16-QAM	-5		
28	7168	5	16-QAM	-6		
29	7168	5	16-QAM	-7		
30	7168	5	16-QAM	-8		

HSDPA Test and Measurement Requirements

Layer 2/3 Protocol Impacts

The protocol structure for HSDPA is outlined in figure 5.

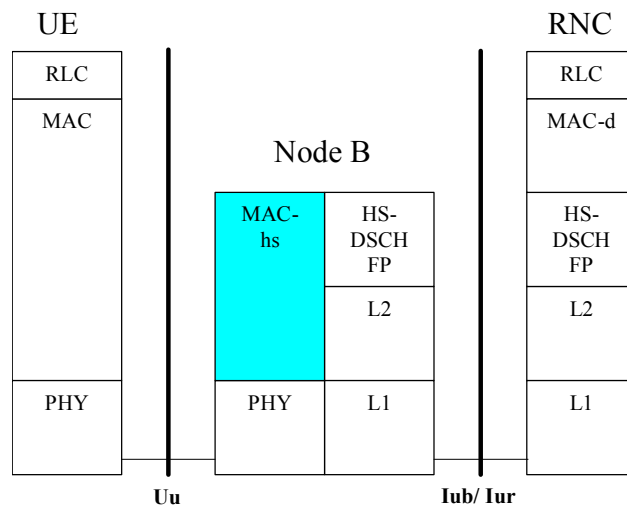

Figure 5 HSDPA Protocol Architecture

Compared to UMTS release 99, significant functionality has been moved to the Node B in release 5. Thus, a new **MAC-hs** (Medium Access Control – high speed) protocol entity has been introduced in the Node B. It is responsible for flow control, scheduling and priority handling of data, control of HARQ processes and selection of appropriate transport formats and resources. The MAC-hs entity is terminated on the UE side.

Within the **Radio Resource Control** (RRC) protocol, existing messages for bearer setup, reconfiguration and release were modified to support HS-DSCH. New information elements were introduced, e.g. to inform the UE about the HS-SCCH set to monitor and about the measurement cycle for the CQI reporting.

Mobility for HSDPA is based on existing release 99 handover procedures. For the HS-PDSCH no macrodiversity is applied, i.e. a specific HS-PDSCH is transmitted in a single cell only.

3 Node B Test and Measurement Requirements for HSDPA

Relevant 3GPP Specifications

Technical Specification **3GPP TS 25.141** focuses on BS conformance tests and contains the relevant HSDPA specific measurement requirements [3]. For Node B transmitter tests, 3GPP TS 25.141 specifies test models that describe the physical channel test setup. A new test model 5 was introduced in 3GPP TS 25.141 for HSDPA, which is used to perform error vector magnitude (EVM) measurements at Node Bs that support 16QAM HS-PDSCH transmission. Due to the 16QAM modulation scheme used on HS-PDSCH, a new EVM requirement was introduced (EVM < 12.5%).

Table 2 taken from 3GPP TS 25.141 outlines the active channels of test model 5. Considering that not every Node B implementation will support 8 HS-PDSCH + 30 DPCH, variants of this test model containing 4 HS-PDSCH + 14 DPCH and 2 HS-PDSCH + 6 DPCH are also specified. The conformance test shall be performed using the largest of these three options that can be supported by the equipment under test.

Table 2 - Test Model 5 Active Channels

Type	Number of Channels	Fraction of Power (%)	Level setting (dB)	Channelization Code	Timing offset (x256T _{chip})
P-CCPCH+SCH	1	7.9	-11	1	0
Primary CPICH	1	7.9	-11	0	0
PICH	1	1.3	-19	16	120
S-CCPCH containing PCH (SF=256)	1	1.3	-19	3	0
DPCH (SF=128)	30/14/6(*)	14/14.2/14.4 in total	see table 6.b in [3]	see table 6.b in [3]	see table 6.b in [3]
HS-SCCH	2	4 in total	see table 6.c in [3]	see table 6.c in [3]	see table 6.c in [3]
HS-PDSCH (16QAM)	8/4/2(*)	63.6/63.4/63.2 in total	see table 6.d in [3]	see table 6.d in [3]	see table 6.d in [3]
Note *: 2 HS-PDSCH shall be taken together with 6 DPCH, 4 HS-PDSCH shall be taken with 14 DPCH, and 8 HS-PDSCH shall be taken together with 30 DPCH.					

In the section “Example Applications” in this chapter, this requirement of 3GPP TS 25.141 as well as additional Node B measurement recommendations are highlighted.

Rohde & Schwarz Test Equipment and Software

Rohde & Schwarz offers two dedicated solutions for Node B measurements:

- The **FSMU-W** Base Station Test Set is a combination of SMU200A signal generator and FSQ signal analyzer, fulfilling the most demanding RF requirements in R&D and production including power amplifier testing and multicarrier/multistandard scenarios. HSDPA analysis and generation are supported.
- The one box **CMU300** radio communication tester is a compact solution for high volume testing in regression testing and production. HSDPA functionality is added with software option CMU-K79.

HSDPA functionality can be easily added on Rohde & Schwarz general purpose signal generators and signal / spectrum analyzers. The Rohde & Schwarz FSx analyzer family (**FSU**, **FSP**, **FSQ**) and the signal analyzer **FSIQ** support HSDPA functionality with software options FS-K74 and FSIQ-K74. For the signal generator **SMU200A**, HSDPA functionality is added with software option SMU-K43. **WinIQSIM** simulation software is used to generate digitally modulated HSDPA signals for driving signal and arbitrary waveform generators. WinIQSIM HSDPA functionality is provided with software option SMU-K20.

Example Applications

Test Model 5 Generation

Development and verification of Node B transmitter components is based on the test models specified in 3GPP TS 25.141. All these test models can be easily generated by the SMU200A, in the downlink part of the 3GPP FDD Baseband Menu:

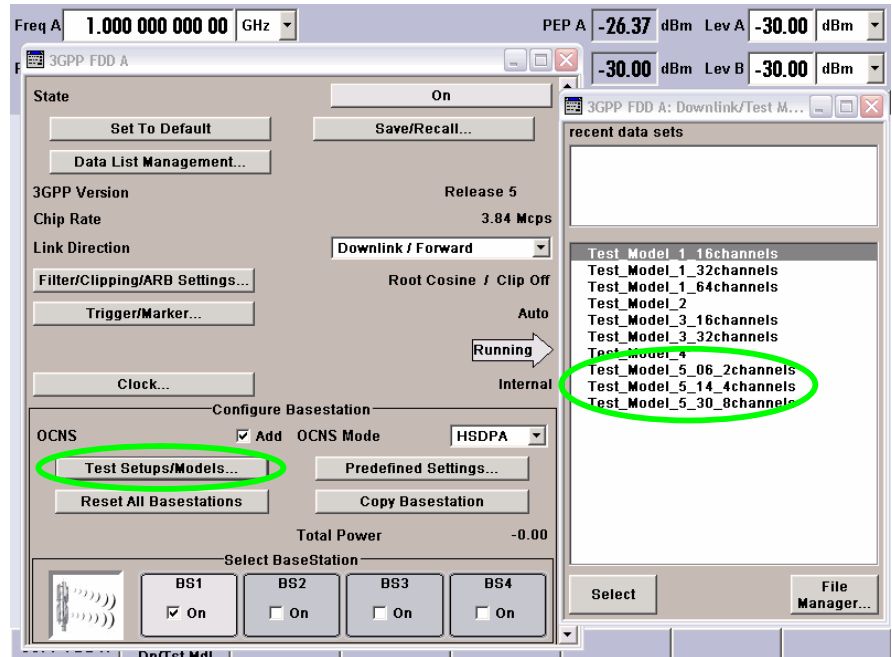

Figure 6 – Selection of Downlink Test Models with SMU200A

Test Model 5 Analysis

In order to analyze a signal complying to test model 5, the FSx analyzer family provides 2 different detection possibilities: Either the entire code domain is searched for active channels within all permissible symbol rates and channel numbers, or the predefined channel table mode (including test model 5) is activated which assumes only those channels in the table defined prior to the measurement to be active. Figure 7 shows the FSQ display for a received signal according to test model 5, with 6 DPCHs of SF 128 and 2 HS-PDSCHs of SF 16 (cmp. table 2). The 16QAM constellation diagram for the selected HS-PDSCH is shown in the lower part of the display. EVM measurements can easily be performed with the available measurement routines.

HSDPA Test and Measurement Requirements

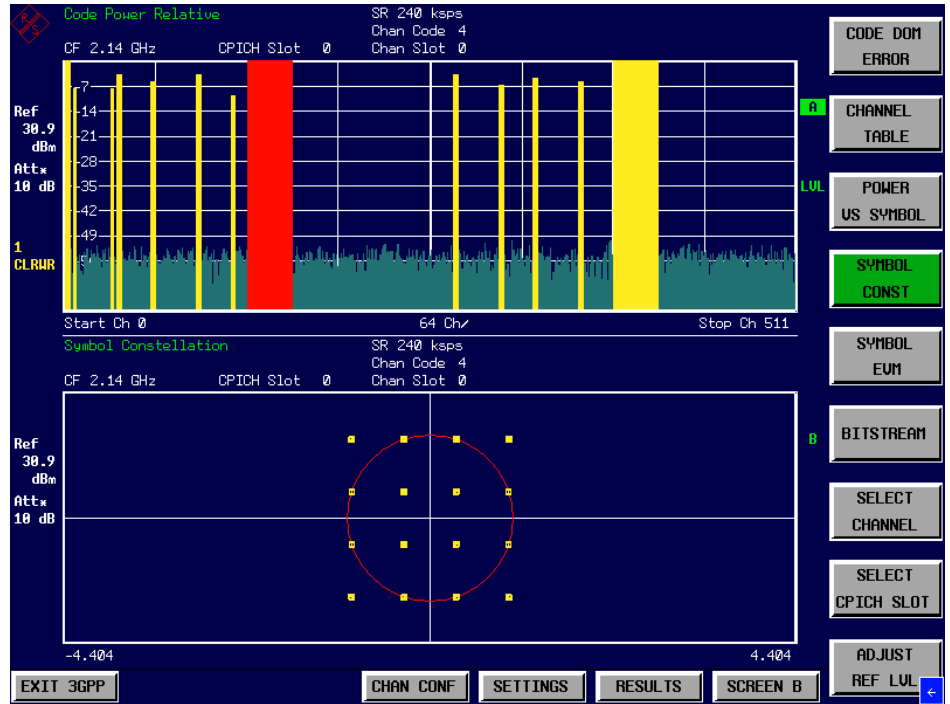

Figure 7 – Code Domain of Test Model 5_06_2 and Constellation Diagram of HS-PDSCH on FSQ

Also the compact base station tester CMU300 supports detection of test model 5. Figure 8 illustrates a code domain power measurement of test model 5_06_2 on CMU300. Additionally, power vs slot and various measurement results including EVM are displayed.

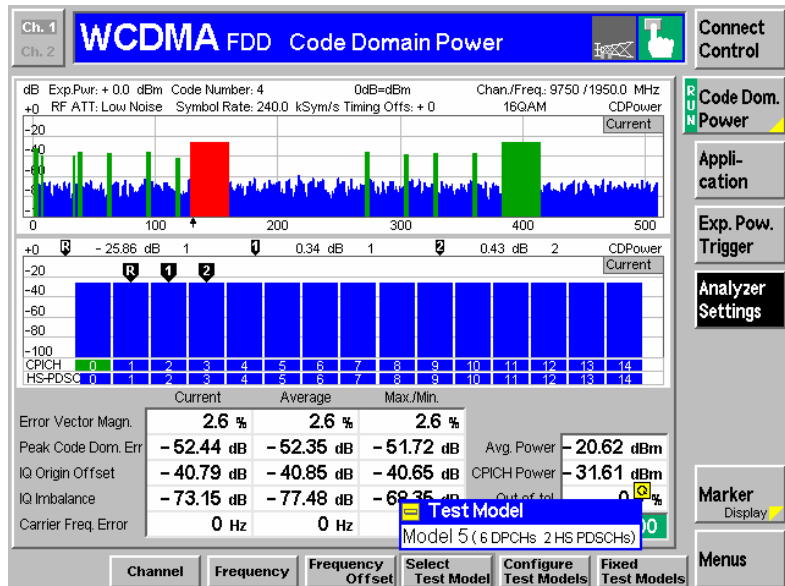

Figure 8 - Code Domain of Test Model 5_06_2 and Power vs Slot on CMU300

HS-DPCCH Detection

Besides modulation quality, performance of ACK/NACK detection and CQI detection is an important criterion for HSDPA capable Node Bs. By generating an uplink HS-DPCCH with a predefined ACK/NACK pattern and/or CQI pattern, the detection performance of the Node B can be verified.

Figure 9 shows how to configure the HS-DPCCH contents with the SMU200A.

HARQ-ACK (Slots) 1		CQI (Slots) 2	
State	<input type="checkbox"/> On	Power	0.00 dB
Start Delay	101 *256 Chips	Inter TTI Distance	5 Subframes
CQI Pattern Length	5	ACK/NACK Pattern (bin)	1110 00-0...
CQI Values	1 30		2 1 4

Figure 9 – Configuration of ACK/NACK and CQI patterns with SMU200A

For the CQI pattern, a certain length can be defined and the corresponding number of CQI values can be set (cmp. table 1). The ACK/NACK pattern is composed of an arbitrary sequence of “1” for ACK and “0” for NACK. DTX values can also be configured, by inserting the value “-1” in the list of CQI values, and “-” in the ACK/NACK pattern.

These pattern sequences are continuously repeated on the HS-DPCCH generated by SMU200A. By stimulating the Node B with this signal, detection of this signal and appropriate reaction by the Node B algorithms can be verified.

4 UE Test and Measurement Requirements for HSDPA

Relevant 3GPP Specifications

Due to the HSDPA specific physical parameters, layer 1 processes and protocol modifications, various new test and measurement requirements for HSDPA capable UEs have been specified. The following 3GPP specifications are relevant:

HSDPA Test and Measurement Requirements

- **3GPP TS 34.121** is the terminal conformance specification for radio transmission and reception (FDD) [4]. For release 5, the following tests are foreseen:

Table 3 – 3GPP TS 34.121 RF Conformance Tests for HSDPA

34.121 – Transmitter Characteristics (FDD)	
TBD	Transmit ON/OFF power, HS-PDCCH
34.121 – Receiver Characteristics (FDD)	
6.3A	Maximum input level, Minimum requirement for HS-PDSCH reception (16QAM)
34.121 – RF Performance (FDD)	
9.2.1	Demodulation of HS-DSCH (Fixed Reference Channel); Single Link
9.2.2	Demodulation of HS-DSCH (Fixed Reference Channel); Open Loop Diversity
9.3.1	Reporting of Channel Quality Indicator; AWGN propagation conditions
9.3.2	Reporting of Channel Quality Indicator; Fading propagation conditions
9.4	HS-SCCH Detection Performance

Section 9 of 3GPP TS 34.121 was specifically introduced for HSDPA and contains test cases for verification of the layer 1 processes including HARQ protocol and adaptive modulation and coding.

Similar to release 99 Reference Measurement Channels, Fixed Reference Channels for HSDPA have been specified in 3GPP TS 34.121. Release 5 contains 5 Fixed Reference Channels, the so-called H-Sets 1-5. They describe the setup of the HS-(P)DSCH for the tests specified in 3GPP TS 34.121.

As example, Table 4 and figure 10 illustrate the structure of H-Set 1 and the parameters that are relevant for coding of the HS-(P)DSCH.

Table 4 – Fixed Reference Channel H-Set 1

Parameter	Unit	Value	
Nominal Avg. Inf. Bit Rate	kbps	534	777
Inter-TTI Distance	TTI's	3	3
Number of HARQ Processes	Processes	2	2
Information Bit Payload (N_{INF})	Bits	3202	4664
Number Code Blocks	Blocks	1	1
Binary Channel Bits Per TTI	Bits	4800	7680
Total Available SML's in UE	SML's	19200	19200
Number of SML's per HARQ Proc.	SML's	9600	9600
Coding Rate		0.67	0.61
Number of Physical Channel Codes	Codes	5	4
Modulation		QPSK	16QAM

Note: SML = Soft Metric Location

HSDPA Test and Measurement Requirements

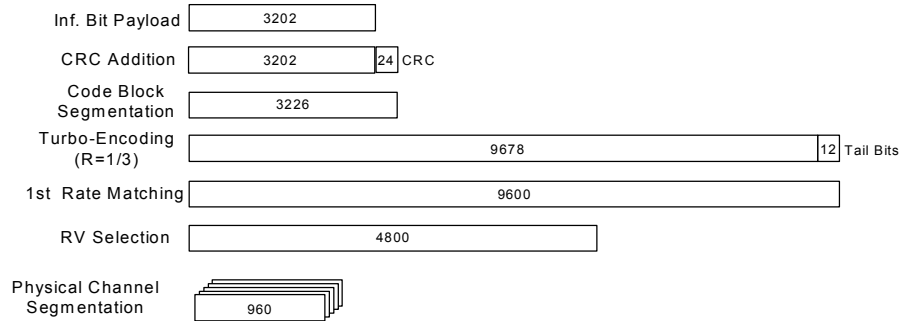

Figure 10 – Coding rate for H-Set 1 (QPSK)

H-Set 1-3 are available in both QPSK and 16 QAM, whereas H-Set 4 and H-Set 5 are based on QPSK.

- **3GPP TS 34.108** describes common test environments for UE conformance testing [5]. Baseline radio bearer combinations for testing HSDPA are specified, and generic setup procedures for HSDPA tests are described.
- **3GPP TS 34.123** is the UE conformance specification for protocol tests [6]. 3GPP TS 34.123 details over 50 HSDPA protocol test cases which will be provided as official TTCN test cases in the near future. HSDPA specific tests for MAC-hs, RRC, NAS protocols and Radio Bearer tests are available.

In the section “Example Applications” in this chapter, major measurement requirements of these 3GPP specifications as well as additional example applications are illustrated by means of Rohde & Schwarz products.

Rohde & Schwarz Test Equipment and Software

HSDPA specific UE transmitter and receiver tests and component development can be performed with the FSx analyzer family (**FSU**, **FSP**, **FSQ**) and the **SMU200A** signal generator. The FSx analyzer family supports HSDPA uplink functionality with software option FS-K73. For the SMU200A, HSDPA functionality is added with software option SMU-K43. **WinIQSIM** simulation software is used to generate digitally modulated HSDPA signals for driving signal and arbitrary waveform generators. WinIQSIM HSDPA functionality is provided with software option SMU-K20.

For UE RF and layer 1 tests in alignment with 3GPP TS 34.121, the compact radio communication tester **CMU200** is the instrument of choice. HSDPA downlink channels can be flexibly configured, and uplink

HSDPA Test and Measurement Requirements

measurements can be performed, including full HARQ and adaptive modulation and coding functionality. HSDPA functionality is added with software option CMU-K64. The CMU200 provides a wide range of RX and TX measurements for WCDMA and HSDPA.

The **CRTU-W/M** protocol test platform offers a powerful set of UE test tools for the whole UE development chain from layer 1 to protocol and conformance test:

- **Layer 1 Test Software** (CRTU-WA01), for flexible HSDPA channel configuration and creation of layer 1 scenarios including downlink/uplink interaction
- **Medium Level C++ Programming Interface** (CRTU-WT02 and CRTU-WA02 for HSDPA support) for creation of individual HSDPA protocol test scenarios including application test
- **TTCN toolchain** for preparing, executing and analyzing TTCN test cases (CRTU-WCxx and CRTU-WA02 for HSDPA support)

Example Applications

Configuration of HS-(P)DSCH

In order to verify the UE receiver chain, flexible configuration possibilities for the HS-(P)DSCH channels are required.

Both Layer 1 Test Software for CRTU-W/M as well as CMU200 allow the user to choose from three different HS-(P)DSCH configuration possibilities:

- **Fixed Reference Channel:** All HS-(P)DSCH parameters are set according to the selected H-Set as specified in 3GPP TS 34.121.
- **CQI value based:** The HS-(P)DSCH is formatted according to the selected CQI value, referring to the CQI tables specified for each UE category in 3GPP TS 25.214.
- **User Defined:** All parameters are individually set. These include number of HS-PDSCH codes, number of Hybrid ARQ processes, modulation scheme, inter TTI distance, transport block size, incremental redundancy buffer size and redundancy version sequence. By applying user defined parameter settings, UE implementations can be tested beyond the limits set by specifications. For example, transport block sizes exceeding H-Set requirements can be set, and

HSDPA Test and Measurement Requirements

the behaviour of the UE implementation under these circumstances can be verified.

Figure 11 shows the HSDPA Configuration window of the Layer 1 Test Software. Depending on which of the three above-mentioned choices has been made, the HS-(P)DSCH parameters are pre-defined (marked in grey) and cannot be altered, or individual parameters can be entered by the user.

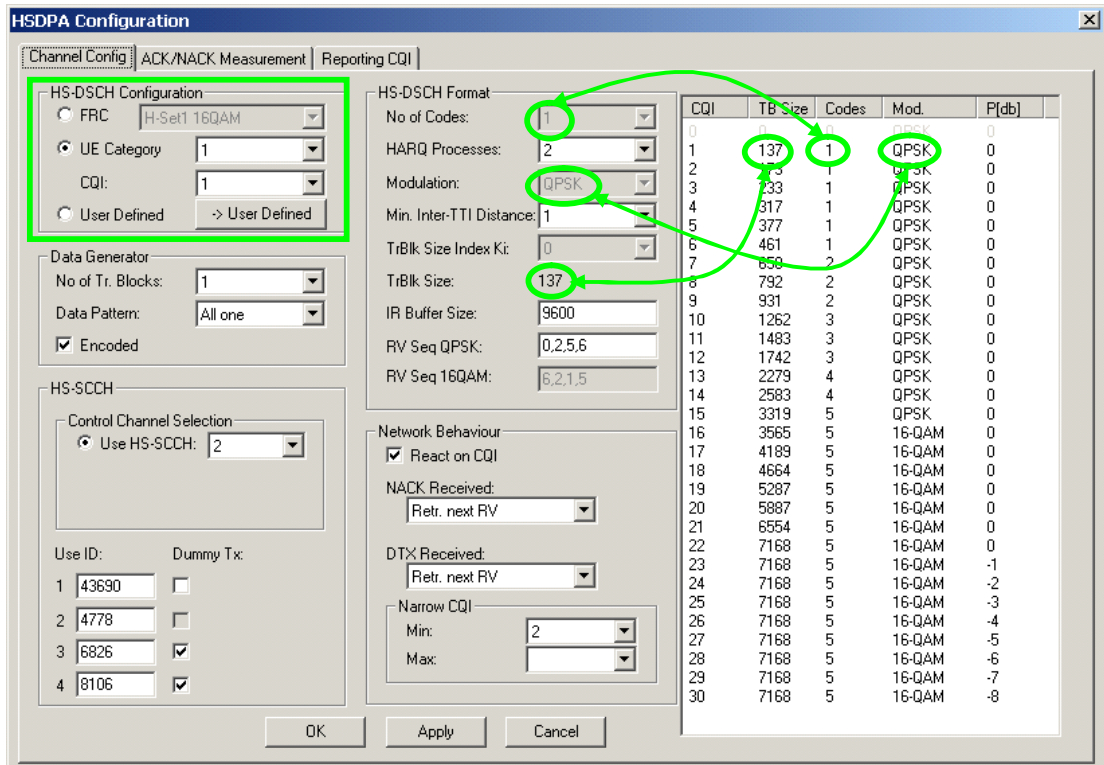

Figure 11 – HS-(P)DSCH Configuration Window of Layer 1 Test Software

Example: In figure 11, HS-(P)DSCH configuration according to CQI value has been selected. UE category 1 is used, and the corresponding CQI table of 3GPP TS 25.214 is displayed for information. CQI value 1 is selected, corresponding to a transport block size of 137 bits, 1 HS-PDSCH code and modulation scheme QPSK. In the HS-DSCH Format view, these settings can therefore not be modified in this case. However, it is possible to input user defined values for number of HARQ processes, inter TTI distance, Incremental Redundancy (IR) buffer size and RV sequence.

Figure 12 shows the HSDPA Configuration window of the CMU200. In this window, HS-SCCH and HS-PDSCH settings can be made.

HSDPA Test and Measurement Requirements

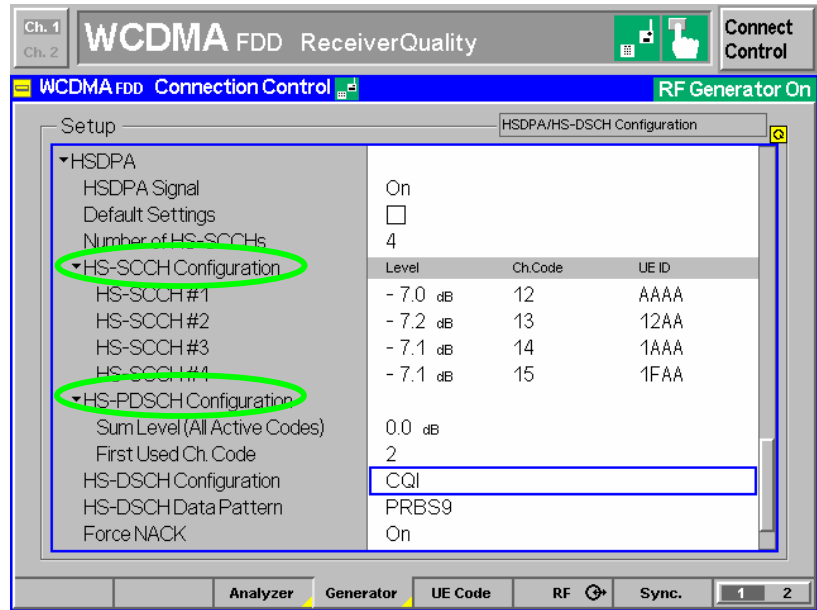

Figure 12 – HSDPA Configuration Menu of CMU200

Figure 13 shows the HS-(P)DSCH configuration options in CMU200.

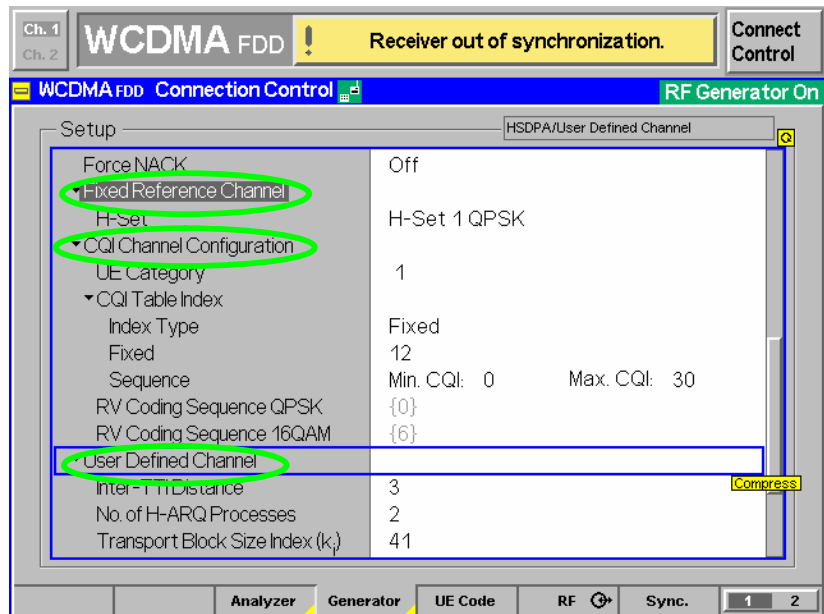

Figure 13 – HS-(P)DSCH Configuration Menu of CMU200

Also with the CMU200, one can choose between the three different HS-(P)DSCH configuration possibilities (Fixed Reference Channel, CQI value based, user defined). When using the CQI value based HS-(P)DSCH configuration, it is possible to specify a sequence of CQI values. This means that from TTI to TTI, the HS-DSCH format is changed according to step wise increasing CQI values. The minimum and maximum CQI value in this sequence can be selected.

HS-DSCH Demodulation Performance

3GPP TS 34.121 requires to verify the ability of the UE to receive a predefined HSDPA test signal, with information bit throughput not falling below a specified value. The test stresses the multicode reception and channel decoding with incremental redundancy.

Both CMU200 and Layer 1 Test Software for CRTU-W/M provide the possibility to verify this HS-DSCH demodulation performance.

Figure 14 outlines the test setup and evaluation of the results. In this example, the Layer 1 Test Software on CRTU-W/M is used. A Fixed Reference Channel according to the UE category under test is generated by the CRTU-W/M. The UE receives the HS-DSCH and responds with ACKs, NACKs or DTX on the uplink HS-DPCCH, depending on whether packets were received and correctly decoded or not.

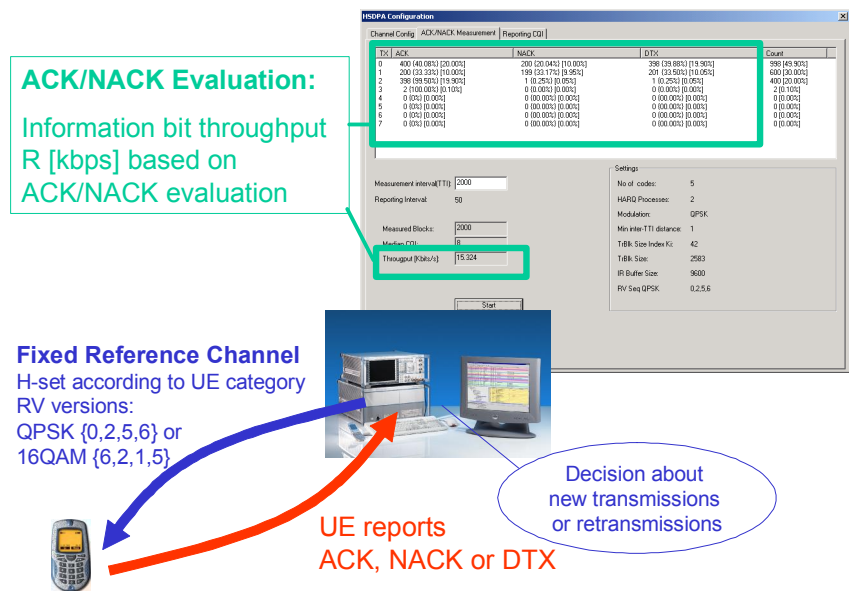

Figure 14 – Demodulation of HS-DSCH (Fixed Reference Channel) with Layer 1 Test Software

The CRTU-W/M each time decides about new transmissions and retransmissions of packets according to the behaviour required by 3GPP TS 34.121 as shown in table 5.

Table 5 – Node B Emulator Behaviour according to 3GPP TS 34.121

HS-DPCCH ACK/NACK Field State	Node-B Emulator Behaviour
ACK	ACK: new transmission using 1 st redundancy and constellation version (RV)
NACK	NACK: retransmission using the next RV (up to the maximum permitted number of RV's)
DTX	DTX: retransmission using the RV previously transmitted to the same H-ARQ process

The behaviour of the CRTU-W/M can be configured in the HSDPA Configuration dialogue window (see figure 11, "Network Behaviour"). When NACK or DTX are received on HS-DPCCH, the CRTU-W/M retransmits with the next redundancy version or with the same redundancy version, respectively. The sequence of redundancy versions is also specified in 3GPP TS 34.121. The coding of the redundancy versions, i.e. the meaning of values {0,2,5,6} for QPSK and {6,2,1,5} for 16QAM as denoted in figure 14 is specified in 3GPP TS 25.212 [7].

The achieved HS-DSCH throughput R [kbps] is evaluated for this setup.

As can be seen in figure 14, the Layer 1 Test Software does not only provide the measurement result for the throughput, but also indicates measured ACK/NACK/DTX values for each redundancy version. This can be used for more detailed evaluations, e.g. verification of likelihood of retransmissions or performance check for certain redundancy versions.

Verification of CQI Reporting

3GPP TS 34.121 requires that the UE receiver is verified to be capable of reporting the channel quality information (CQI) within a tolerable variance. Furthermore, block error rate on HS-DSCH using the transport format corresponding to the reported CQI median is checked. Both CMU200 and Layer 1 Test Software for CRTU-W/M provide the possibility to verify the UE mechanism for CQI reporting.

Figure 15 outlines the test setup and evaluation of the results. In this example, the Layer 1 Test Software on CRTU-W/M is used.

HSDPA Test and Measurement Requirements

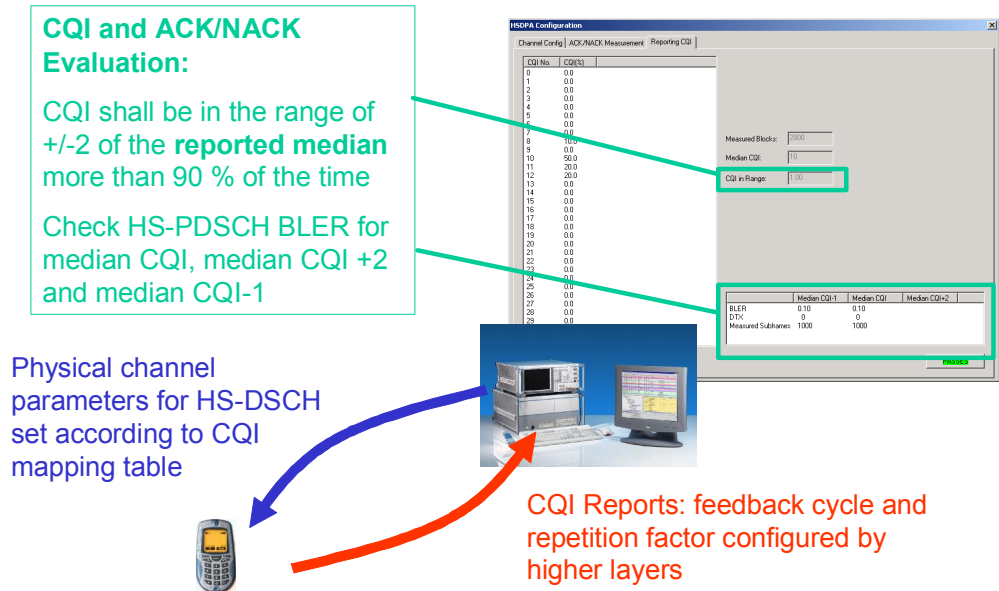

Figure 15 – Verification of CQI reporting with Layer 1 Test Software

In a **first test step**, the CRTU-W/M sends HS-DSCH with a fixed transport format according to CQI value 16 (as requested by 3GPP TS 34.121). This transport format is kept regardless of the CQI values reported by the UE, i.e. the CRTU-W/M ignores the CQI values reported by the UE. This behaviour can be configured in the “react on CQI” checkbox of the HSDPA Configuration dialogue, see figure 11. For any HSDPA block transmitted by the CRTU-W/M, the CQI value reported by the UE is logged. 2000 measurement values are collected, and the median CQI value is determined. 90% of the CQI values reported by the UE shall be in the range of +/- 2 of this median CQI value, otherwise the UE fails this test. Median CQI value and the number of CQI values in range are displayed by the Layer 1 Test Software. A detailed view on how often each CQI value was reported is also displayed (see figure 15).

If the UE passes this test, a **second test step** is carried out. This step verifies the BLER performance for the reported median CQI. The CRTU-W/M transmits the HS-DSCH with a fixed transport format corresponding to the median CQI value determined in the first step. Again, the CRTU-W/M does not react upon the CQI values reported by the UE. ACK, NACK or DTX as reported by the UE are logged. For HS-DSCH BLER calculation, ACK received is recorded as success, while NACK or DTX received are recorded as fail. If the resulting BLER for the median CQI is < 0.1, then median CQI+2 is configured to check that the BLER for this value is > 0.1.

If the resulting BLER for the median CQI is > 0.1, then median CQI-1 is configured to check that the BLER for this value is < 0.1.

HS-SCCH Detection Performance

3GPP TS 34.121 verifies the detection performance of the HS-SCCH, which is determined by the probability of event E_m . This event is declared when the UE is signalled on a HS-SCCH, but DTX is observed in the corresponding HS-DPCCH ACK/NACK field. The probability of event E_m is denoted $P(E_m)$. The test verifies that $P(E_m)$ does not exceed a specified limit.

Both CMU200 and Layer 1 Test Software for CRTU-W/M provide the possibility to verify the UE mechanism for CQI reporting. Figure 16 outlines the test setup and evaluation of the results. In this example, the Layer 1 Test Software on CRTU-W/M is used.

The UE under test is addressed by a predefined HS-SCCH, and HS-DSCH data is scheduled to the UE. If the UE has received a packet, it reports ACK or NACK. If the HS-SCCH was not properly detected, no packet on HS-DSCH can be received and the UE is transmitting DTX. The probability of this event E_m can be determined with the measurements made by the Layer 1 Test Software which is counting ACK, NACK and DTX as received on the uplink HS-DPCCH.

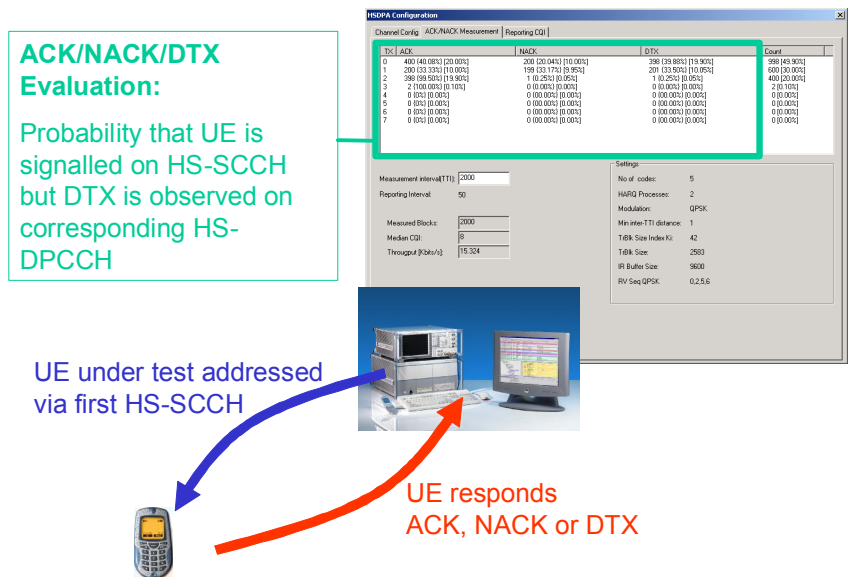

Figure 16 – HS-SCCH Detection Performance with Layer 1 Test Software

Again, the ACK/NACK measurement window of Layer 1 Test Software is used for this evaluation.

HSDPA Protocol Test Cases and Scenarios

The major part of protocol test cases in 3GPP TS 34.123 is formed by RRC (Radio Resource Control) test cases which verify different RRC procedures in the presence of HS-DSCH. These include procedures for Radio Bearer Establishment, Reconfiguration and Release, as well as Physical Channel Reconfiguration, Cell Update, Active Set Update, Inter-System Handover and Inter-System Cell Change Order. TTCN test cases will be made available by the standardization groups app. mid 2005, and will then be supported on Rohde & Schwarz CRTU-W platform.

Already before official TTCN test cases are available, the CRTU-W platform offers a powerful tool for HSDPA scenario creation, the Medium Level C++ Programming Interface. RRC messages and message sequences can be individually configured, e.g. for HSDPA bearer setup, reconfiguration and release. HSDPA specific information elements contained in RRC messages can be individually set. Figure 17 exemplarily shows the analysis of a Radio Bearer Setup procedure for HSDPA. In the Message Analyzer software running on CRTU-W, message sequence charts are illustrated, and individual messages can be analyzed down to information element level.

HSDPA Test and Measurement Requirements

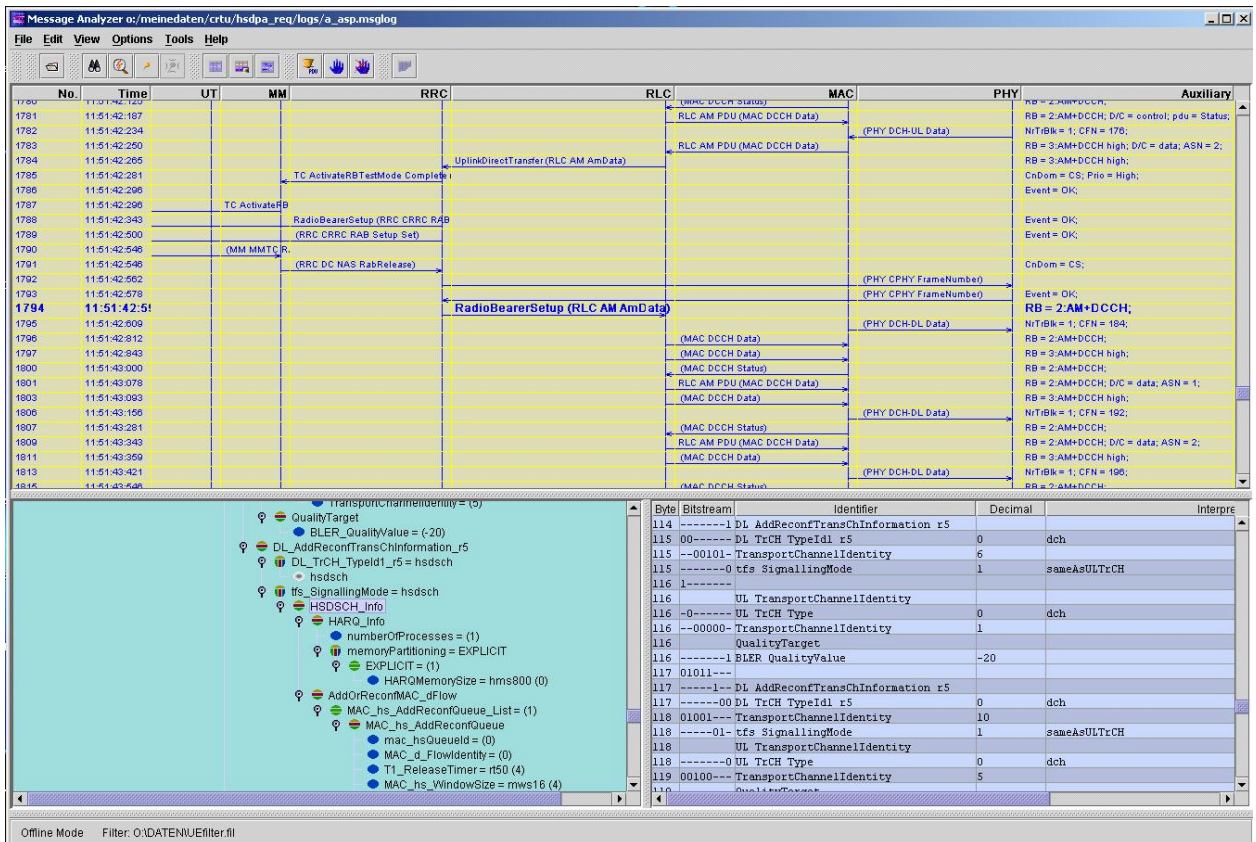

Figure 17 – HSDPA Radio Bearer Setup in Message Analyzer

5 Abbreviations

3GPP	3rd Generation Partnership Project
ACK	Acknowledgement
AMC	Adaptive Modulation and Coding
BLER	Block Error Rate
CQI	Channel Quality Information
DPCH	Dedicated Physical Channel
DTX	Discontinuous Transmission
EVM	Error Vector Magnitude
FP	Frame Protocol
GPRS	General Packet Radio Service
GSM	Global System for Mobile Communications

HSDPA Test and Measurement Requirements

HARQ	Hybrid Automatic Repeat Request
HSDPA	High Speed Downlink Packet Access
HS-DPCCH	High Speed Dedicated Physical Control Channel
HS-(P)DSCH	High Speed (Physical) Downlink Shared Channel
HS-SCCH	High Speed Shared Control Channel
MAC	Medium Access Control
MAC-hs	Medium Access Control – high speed
NACK	Negative Acknowledgement
NAS	Non-Access Stratum
PHY	Physical Layer
QPSK	Quadrature Phase Shift Keying
QAM	Quadrature Amplitude Modulation
RLC	Radio Link Control
RRC	Radio Resource Control
RV	Redundancy Version
SF	Spreading Factor
SML	Soft Metric Location
TS	Technical Specification
TTCN	Tree and Tabular Combined Notation
TTI	Transmission Time Interval
UE	User Equipment
UMTS	Universal Mobile Telecommunications System

6 Additional Information

This application note is updated from time to time. Please visit the website [1MA82](#) in order to download new versions.

Please contact TM-Applications@rsd.rohde-schwarz.com for comments and further suggestions.

7 References

- [1] 3GPP TS 25.306; UE Radio Access capabilities definition (Release 5)
- [2] 3GPP TS 25.214; Physical layer procedures (FDD) (Release 5)
- [3] 3GPP TS 25.141; BS conformance testing (FDD) (Release 5)
- [4] 3GPP TS 34.121; Terminal conformance specification ; Radio transmission / reception (FDD) (Release 5)
- [5] 3GPP TS 34.108; Common test environments for UE conformance testing (Release 5)
- [6] 3GPP TS 34.123; UE conformance specification (Release 5)
- [7] 3GPP TS 25.212; Multiplexing and channel coding (FDD) (Release 5)

8 Ordering information

Universal Radio Communication Tester (UE)

R&S® CMU200		1100.0008.02
R&S® CMU-K64	SW-option for CMU200: HSDPA 3GPP	1157.3970.02

Universal Radio Communication Tester (Node B)

R&S® CMU300		1100.0008.03
R&S® CMU-K79	HSDPA TX Measurements (Non-Signalling) 3GPP/FDD/DL	1150.4407.02

FSMU-W WCDMA Base Station Test Set

R&S® FSMU3-W	Based on Signal Analyzer R&S® FSQ3	1166.1554.03
R&S® FSMU8-W	Based on Signal Analyzer R&S® FSQ8	1166.1554.08
R&S® FSMU26-W	Based on Signal Analyzer R&S® FSQ26	1166.1554.26

Vector Signal Generator

R&S® SMU200A		1141.2005.02
R&S® SMU-B102	Frequency range 100 KHz to 2.2 GHz for 1st RF Path	1141.8503.02

HSDPA Test and Measurement Requirements

R&S® SMU-B103	Frequency range 100 KHz to 3GHz for 1st RF Path	1141.8603.02
R&S® SMU-B104	Frequency range 100 KHz to 4GHz for 1st RF Path	1141.8703.02
R&S® SMU-B106	Frequency range 100 KHz to 6 GHz for 1st RF Path	1141.8803.02
R&S® SMU-B202	Frequency range 100 KHz to 2.2 GHz for 2nd RF Path	1141.9400.02
R&S® SMU-B203	Frequency range 100 KHz to 3 GHz for 2nd RF Path	1141.9500.02
R&S® SMU-B10	Baseband Generator with digital modulation (realtime) and ARB (64MSamples)	1141.7007.02
R&S® SMU-B11	Baseband Generator with digital modulation (realtime) and ARB (16MSamples)	1159.8411.02
R&S® SMU-B13	Baseband Main Module	1141.8003.02
R&S® SMU-B14	Fading Simulator	1160.1800.02
R&S® SMU-B15	Fader Extension	1160.2288.02
R&S® SMU-K71	Enhanced Resolution and Dynamic Fading	1160.9201.02
R&S® SMU-K42	Digital Standard 3GPP FDD	1160.7909.02
R&S® SMU-K43	3GPP FDD Enhanced MS/BS Tests incl. HSDPA	1160.9660.02
R&S® SMU-K20	3GPP FDD incl. HSDPA for WinIQSIM	1160.9460.02

Signal Analyzers, Spectrum Analyzers and Options

R&S® FSP3	9 kHz to 3 GHz	1164.4391.03
R&S® FSP7	9 kHz to 7 GHz	1164.4391.07
R&S® FSP13	9 kHz to 13 GHz	1164.4391.13
R&S® FSP30	9 kHz to 30 GHz	1164.4391.30
R&S® FSP40	9 kHz to 40 GHz	1164.4391.40
R&S® FSQ3	20 Hz to 3.6 GHz	1155.5001.03
R&S® FSQ8	20 Hz to 8 GHz	1155.5001.08
R&S® FSQ26	20 Hz to 26.5 GHz	1155.5001.26
R&S® FSQ40	20 Hz to 40 GHz	1155.5001.40
R&S® FSU3	20 Hz to 3.6 GHz	1166.1660.03
R&S® FSU8	20 Hz to 8 GHz	1166.1660.08
R&S® FSU26	20 Hz to 26.5 GHz	1166.1660.26
R&S® FSU46	20 Hz to 46 GHz	1166.1660.46
R&S® FSU50	20 Hz to 50 GHz	1166.1660.50

R&S® FS-K72	Application Firmware 3GPP-FDD BTS	1154.7000.02
R&S® FS-K73	Transmitter Test for FSP, FSU, FSQ Application Firmware 3GPP-FDD UE	1154.7252.02
R&S® FS-K74	Transmitter Test for FSP, FSU, FSQ 3GPP HSDPA Base Station Test Application	1300.7156.02
R&S® FSIQ-K72	Firmware for FSP, FSU, FSQ Application Firmware 3GPP-FDD BTS	1126.4746.02
R&S® FSIQ-K74	Transmitter Test for FSIQ 3GPP HSDPA Base Station Test Application	1153.1109.02
	Firmware for FSIQ	

Protocol Tester

R&S® CRTU-W		1140.0509K02
R&S® CRTU-M		1140.2101K02
R&S® CRTU-WA01	HSDPA/L1 Test Software	1166.0106.02
R&S® CRTU-WA02	HSDPA Signalling	1166.0158.02
R&S® CRTU-WT02	C Application Development Tools	1156.3377.02

HSDPA Test and Measurement Requirements



ROHDE & SCHWARZ

ROHDE & SCHWARZ GmbH & Co. KG · Mühlendorfstraße 15 · D-81671 München · P.O.B 80 14 69 · D-81614 München ·
Telephone +49 89 4129 -0 · Fax +49 89 4129 - 13777 · Internet: <http://www.rohde-schwarz.com>

This application note and the supplied programs may only be used subject to the conditions of use set forth in the download area of the Rohde & Schwarz website.